

MUELLES/RESORTES DE TRACCION

Los muelles/resortes de tracción de SPEC tienen un amplio número de aplicaciones en trabajos experimentales, de desarrollo, prototipos y de mantenimiento y han sido concebidos y diseñados según los más altos niveles de precisión.

MATERIALES

Referencia "E"

Alambre de piano: ASTM A228 ó AMS 5112

Acero inoxidable: Tipo 302 según ASTM A313 ó AMS 5688 templado (químico y mecánico solamente).

Referencia "T"

Alambre de piano: DIN 17223 ó JIS G4314 A313 SWP-A/B ó AMS 5112

Acero inoxidable : Tipo 301, 302 ó 304 según DIN 17224 ó JIS G4314 SUS 302/304 ó templado de resorte AMS 5688 (químico y mecánico solamente).

TOLERANCIAS

Referencia "E"

Diámetro externo	
1.45 a 3.02mm	+/-0.08mm
3.05 a 6.10mm	+/-0.13mm
6.12 a 12.70mm	+/-0.20mm
12.73 a 25.40mm	+/-0.38mm
25.43 a 31.12mm	+/-0.51mm
31.14 a 37.08mm	+/-0.76mm
37.11 a 50.08mm	+/-1.02mm
Carga P	+/- 10%
Coefficiente tracción R	+/- 10%

Referencia "T"

Todas las dimensiones y fuerzas según DIN 2097 (Grado 2).

CLAVES DE CARACTERÍSTICAS

Do = Diámetro exterior

d = Diámetro del alambre

Lo = Longitud libre

L₁ = Longitud máxima extendida

P₁ = Carga a L₁

T = Tensión inicial

R = Coeficiente de tracción

La tensión inicial es solamente referencial y puede variar.

INFORMACIÓN TÉCNICA ADICIONAL

Todos los muelles/resortes de tracción de SPEC tienen un diámetro uniforme de cuerpo y se fabrican con espiras enteras, cuyo diámetro es igual que el cuerpo. Se enrollan con una tensión inicial. Por lo tanto, es preciso aplicar un poco de fuerza antes de que se puedan separar las espiras.

EXTREMOS

Espiras alemanas cerradas. La posición del extremo puede variar.

CARGAS

La tensión inicial T es solamente referencial y puede variar. Con el fin de determinar la carga a cualquier longitud de trabajo, utilice $P = (L - L_x) \times R$ donde L_x es la longitud de trabajo + tensión inicial.

1 lb = 4,448 Newtons

1 Newton = 0,225 lb

ACABADO SUPERFICIAL

Alambre de piano lubricado.

Acero inoxidable – alambre normal.

Bajo pedido granallado y con acabados especiales.

Requieren de un plazo superior.

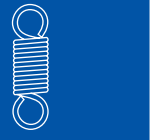
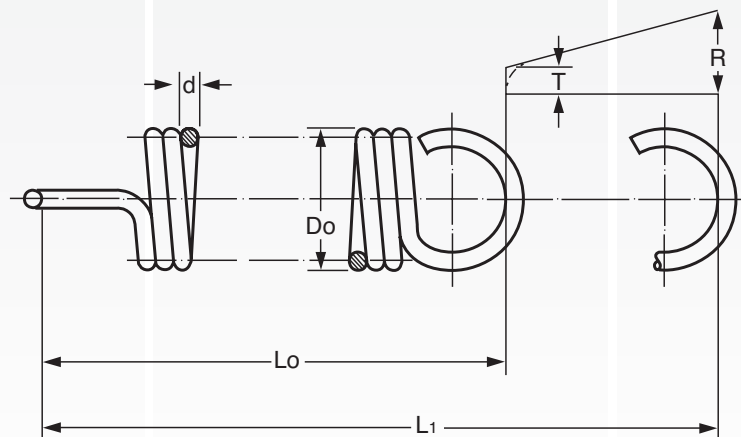

EXTENSION SPRINGS - MUSIC WIRE								STAINLESS STEEL / INOX			
Part Number	Do (mm)	d (mm)	Lo (mm)	L ₁ (mm)	P (N)	T (N)	R (N/mm)	Part Number	P (N)	T (N)	R (N/mm)
E0063-007-0250-M			6.35	13.72			0.18	E0063-007-0250S			0.15
E0063-007-0310-M			7.87	18.54			0.12	E0063-007-0310S			0.10
E0063-007-0380-M		0.18	9.65	23.62	1.423	0.13	0.09	E0063-007-0380S	1.18	0.11	0.07
E0063-007-0440-M			11.18	28.45			0.07	E0063-007-0440S			0.06
E0063-007-0500-M			12.70	33.27			0.07	E0063-007-0500S			0.06
E0063-008-0250-M			6.35	11.68			0.35	E0063-008-0250S			0.29
E0063-008-0310-M			7.87	15.24			0.25	E0063-008-0310S			0.20
E0063-008-0380-M			9.65	19.05			0.19	E0063-008-0380S			0.16
E0063-008-0440-M		0.20	11.18	23.11	2.00	0.18	0.16	E0063-008-0440S	1.67	0.15	0.13
E0063-008-0500-M			12.70	26.67			0.12	E0063-008-0500S			0.10
E0063-008-0620-M			15.75	34.04			0.11	E0063-008-0620S			0.09
E0063-008-0750-M			19.05	41.66			0.09	E0063-008-0750S			0.07
E0063-009-0250-M	1.60		6.35	10.16			0.65	E0063-009-0250S			0.54
E0063-009-0310-M			7.87	13.21			0.47	E0063-009-0310S			0.39
E0063-009-0380-M			9.65	16.51			0.37	E0063-009-0380S			0.31
E0063-009-0440-M		0.23	11.18	19.56	2.76	0.27	0.30	E0063-009-0440S	2.30	0.22	0.25
E0063-009-0500-M			12.70	22.86			0.25	E0063-009-0500S			0.20
E0063-009-0620-M			15.75	28.70			0.19	E0063-009-0620S			0.16
E0063-009-0750-M			19.05	35.56			0.16	E0063-009-0750S			0.13
E0063-011-0250-M			6.35	8.64			1.94	E0063-011-0250S			1.62
E0063-011-0310-M			7.87	11.18			1.38	E0063-011-0310S			1.15
E0063-011-0380-M			9.65	13.97			1.03	E0063-011-0380S			0.86
E0063-011-0440-M		0.28	11.18	16.51	4.85	0.44	0.84	E0063-011-0440S	4.04	0.37	0.70
E0063-011-0500-M			12.70	18.80			0.72	E0063-011-0500S			0.60
E0063-011-0620-M			15.75	23.62			0.56	E0063-011-0620S			0.47
E0063-011-0750-M			19.05	28.96			0.44	E0063-011-0750S			0.37
E0094-010-0380-M			9.65	21.34			0.21	E0094-010-0380S			0.18
E0094-010-0440-M			11.18	26.16			0.16	E0094-010-0440S			0.13
E0094-010-0500-M			12.70	31.24			0.14	E0094-010-0500S			0.12
E0094-010-0620-M		0.25	15.75	40.64	2.67	0.22	0.11	E0094-010-0620S	2.22	0.18	0.09
E0094-010-0750-M			19.05	50.80			0.07	E0094-010-0750S			0.06
E0094-010-0880-M			22.35	59.18			0.05	E0094-010-0880S			0.04
E0094-010-1000-M			25.40	68.33			0.05	E0094-010-1000S			0.04
E0094-011-0380-M			9.65	18.29			0.33	E0094-011-0380S			0.28
E0094-011-0440-M			11.18	22.10			0.26	E0094-011-0440S			0.22
E0094-011-0500-M			12.70	26.16			0.21	E0094-011-0500S			0.18
E0094-011-0620-M		0.28	15.75	34.04	3.11	0.27	0.16	E0094-011-0620S	2.59	0.22	0.13
E0094-011-0750-M			19.05	42.67			0.12	E0094-011-0750S			0.10
E0094-011-0880-M			22.35	51.31			0.11	E0094-011-0880S			0.09
E0094-011-1000-M			25.40	59.18			0.09	E0094-011-1000S			0.07
E0094-012-0380-M			9.65	16.76			0.56	E0094-012-0380S			0.47
E0094-012-0440-M			11.18	20.83			0.42	E0094-012-0440S			0.35
E0094-012-0500-M			12.70	24.13			0.35	E0094-012-0500S			0.29
E0094-012-0620-M		0.30	15.75	30.99	4.45		0.26	E0094-012-0620S	3.71		0.22
E0094-012-0750-M			19.05	38.10			0.21	E0094-012-0750S			0.18
E0094-012-0880-M			22.35	46.23			0.18	E0094-012-0880S			0.15
E0094-012-1000-M	2.39		25.40	53.34		0.44	0.14	E0094-012-1000S		0.37	0.12
E0094-013-0380-M			9.65	15.24			0.81	E0094-013-0380S			0.67
E0094-013-0440-M			11.18	18.54			0.63	E0094-013-0440S			0.53
E0094-013-0500-M			12.70	21.59			0.53	E0094-013-0500S			0.44
E0094-013-0620-M		0.33	15.75	27.69	5.12		0.39	E0094-013-0620S	4.26		0.32
E0094-013-0750-M			19.05	34.29			0.30	E0094-013-0750S			0.25
E0094-013-0880-M			22.35	41.15			0.25	E0094-013-0880S			0.20
E0094-013-1000-M			25.40	47.24			0.21	E0094-013-1000S			0.18
E0094-014-0380-M			9.65	14.48			1.24	E0094-014-0380S			1.04
E0094-014-0440-M			11.18	17.27			0.96	E0094-014-0440S			0.80
E0094-014-0500-M			12.70	20.07			0.81	E0094-014-0500S			0.67
E0094-014-0620-M		0.36	15.75	25.65	6.67	0.76	0.60	E0094-014-0620S	5.56	0.63	0.50
E0094-014-0750-M			19.05	31.24			0.47	E0094-014-0750S			0.39
E0094-014-0880-M			22.35	37.85			0.39	E0094-014-0880S			0.32
E0094-014-1000-M			25.40	43.18			0.33	E0094-014-1000S			0.28
E0094-016-0380-M			9.65	13.21			2.49	E0094-016-0380S			2.07
E0094-016-0440-M			11.18	15.75			1.93	E0094-016-0440S			1.60
E0094-016-0500-M			12.70	18.03			1.61	E0094-016-0500S			1.34
E0094-016-0620-M		0.41	15.75	23.11	9.56	0.85	1.19	E0094-016-0620S	7.96	0.71	0.99
E0094-016-0750-M			19.05	28.45			0.93	E0094-016-0750S			0.77
E0094-016-0880-M			22.35	33.78			0.77	E0094-016-0880S			0.64
E0094-016-1000-M			25.40	38.61			0.65	E0094-016-1000S			0.54
T30800			7.90	9.61			7.98	T40800			6.65
T30810	2.50	0.50	10.90	13.64	16.10	2.45	4.98	T40810	13.41	2.04	4.15
T30820			15.40	19.68			3.19	T40820			2.66

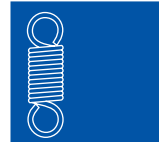

EXTENSION SPRINGS - MUSIC WIRE								STAINLESS STEEL / INOX			
Part Number	Do (mm)	d (mm)	Lo (mm)	L ₁ (mm)	P (N)	T (N)	R (N/mm)	Part Number	P (N)	T (N)	R (N/mm)
T30930			8.80	10.78			8.18	T40930			6.81
T30940	2.80	0.55	12.10	15.27	19.00	2.79	5.11	T40940	15.83	2.33	4.26
T30950			17.00	21.96			3.27	T40950			2.72
T31050			9.70	11.55			12.10	T41050			10.08
T31060	3.00	0.63	13.50	16.46	26.20	3.92	7.51	T41060	21.82	3.27	6.26
T31070			19.20	23.82			4.81	T41070			4.01
E0120-014-0620-M			15.75	31.75			0.28	E0120-014-0620S			0.23
E0120-014-0750-M			19.05	40.13			0.21	E0120-014-0750S			0.18
E0120-014-0880-M			22.35	48.77			0.18	E0120-014-0880S			0.15
E0120-014-1000-M		0.36	25.40	56.64	4.98	0.44	0.14	E0120-014-1000S	4.15	0.37	0.12
E0120-014-1120-M			28.45	64.26			0.12	E0120-014-1120S			0.10
E0120-014-1250-M			31.75	72.90			0.11	E0120-014-1250S			0.09
E0120-014-1370-M			34.80	80.52			0.11	E0120-014-1370S			0.09
E0120-014-1500-M			38.10	89.15			0.09	E0120-014-1500S			0.07
E0120-016-0380-M			9.65	14.48			1.38	E0120-016-0380S			1.15
E0120-016-0500-M			12.70	20.83			0.81	E0120-016-0500S			0.67
E0120-016-0620-M			15.75	27.18			0.58	E0120-016-0620S			0.48
E0120-016-0750-M			19.05	34.04			0.44	E0120-016-0750S			0.37
E0120-016-0880-M			22.35	41.15			0.35	E0120-016-0880S			0.29
E0120-016-1000-M		0.41	25.40	45.97	7.12		0.30	E0120-016-1000S	5.93		0.25
E0120-016-1120-M			28.45	52.58			0.25	E0120-016-1120S			0.20
E0120-016-1250-M			31.75	58.67			0.23	E0120-016-1250S			0.19
E0120-016-1370-M			34.80	65.28			0.19	E0120-016-1370S			0.16
E0120-016-1500-M			38.10	71.63			0.18	E0120-016-1500S			0.15
E0120-016-1750-M			44.45	87.63			0.16	E0120-016-1750S			0.13
E0120-016-2000-M			50.80	100.84		0.89	0.12	E0120-016-2000S		0.74	0.10
E0120-018-0380-M			9.65	13.21			2.52	E0120-018-0380S			2.10
E0120-018-0500-M			12.70	18.80			1.51	E0120-018-0500S			1.25
E0120-018-0620-M			15.75	24.13			1.07	E0120-018-0620S			0.89
E0120-018-0750-M			19.05	30.23			0.82	E0120-018-0750S			0.69
E0120-018-0880-M			22.35	36.07			0.67	E0120-018-0880S			0.55
E0120-018-1000-M		0.46	25.40	40.64	9.79		0.58	E0120-018-1000S	8.16		0.48
E0120-018-1120-M			28.45	45.97			0.49	E0120-018-1120S			0.41
E0120-018-1250-M			31.75	51.56			0.44	E0120-018-1250S			0.37
E0120-018-1370-M	3.05		34.80	57.15			0.39	E0120-018-1370S			0.32
E0120-018-1500-M			38.10	62.74			0.35	E0120-018-1500S			0.29
E0120-018-1750-M			44.45	73.66			0.30	E0120-018-1750S			0.25
E0120-018-2000-M			50.80	84.84			0.25	E0120-018-2000S			0.20
E0120-018-2250-M			57.15	98.81			0.23	E0120-018-2250S			0.19
E0120-020-0500-M			12.70	17.27			2.64	E0120-020-0500S			2.20
E0120-020-0620-M			15.75	22.10			1.89	E0120-020-0620S			1.58
E0120-020-0750-M			19.05	27.43			1.45	E0120-020-0750S			1.21
E0120-020-0880-M			22.35	32.77			1.17	E0120-020-0880S			0.98
E0120-020-1000-M			25.40	36.83			1.05	E0120-020-1000S			0.88
E0120-020-1120-M		0.51	28.45	41.66	13.34	1.33	0.91	E0120-020-1120S	11.11	1.11	0.76
E0120-020-1250-M			31.75	46.74			0.79	E0120-020-1250S			0.66
E0120-020-1370-M			34.80	51.82			0.70	E0120-020-1370S			0.58
E0120-020-1500-M			38.10	56.64			0.65	E0120-020-1500S			0.54
E0120-020-1750-M			44.45	66.55			0.54	E0120-020-1750S			0.45
E0120-020-2000-M			50.80	76.45			0.46	E0120-020-2000S			0.38
E0120-020-2250-M			57.15	88.14			0.39	E0120-020-2250S			0.32
E0120-022-0620-M			15.75	20.57			3.20	E0120-022-0620S			2.67
E0120-022-0750-M			19.05	25.40			2.45	E0120-022-0750S			2.04
E0120-022-0880-M			22.35	30.23			2.00	E0120-022-0880S			1.66
E0120-022-1000-M			25.40	34.54			1.70	E0120-022-1000S			1.42
E0120-022-1120-M			28.45	39.12			1.49	E0120-022-1120S			1.24
E0120-022-1250-M		0.56	31.75	43.94	17.30	1.56	1.30	E0120-022-1250S	14.41	1.30	1.08
E0120-022-1370-M			34.80	48.26			1.17	E0120-022-1370S			0.98
E0120-022-1500-M			38.10	53.09			1.05	E0120-022-1500S			0.88
E0120-022-1750-M			44.45	62.23			0.88	E0120-022-1750S			0.73
E0120-022-2000-M			50.80	71.63			0.75	E0120-022-2000S			0.63
E0120-022-2250-M			57.15	80.77			0.67	E0120-022-2250S			0.55
E0120-022-2500-M			63.50	89.92			0.60	E0120-022-2500S			0.50
T30830			9.50	13.82			2.35	T40830			1.96
T30840			12.50	19.41			1.47	T40840			1.23
T30850		0.50	17.00	27.80	12.00	1.77	0.94	T40850	10.00	1.47	0.78
T30860	3.50		24.50	41.80			0.59	T40860			0.49
T30870			290.00	500.00			0.05	T40870			0.04
T30960			9.90	13.58			3.63	T40960			3.02
T30970		0.55	13.20	19.09	15.70	2.38	2.27	T40970	13.08	1.98	1.89
T30980			18.10	27.30			1.45	T40980			1.21

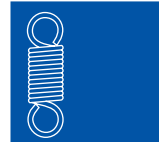

EXTENSION SPRINGS - MUSIC WIRE								STAINLESS STEEL / INOX					
Part Number	Do (mm)	d (mm)	Lo (mm)	L ₁ (mm)	P (N)	T (N)	R (N/mm)	Part Number	P (N)	T (N)	R (N/mm)		
T30990	3.50	0.55	26.40	41.10	15.70	2.38	0.90	T40990	13.08	1.98	0.75		
T31170			11.10	13.46			11.10	T41170			9.25		
T31180		0.70	15.30	19.08	30.70	4.48	6.95	T41180			25.57	3.73	5.79
T31190	4.00	0.80	21.60	27.50			4.44	T41190			3.70		
T31290			12.60	15.26			12.70	T41290			10.58		
T31300			17.40	21.66	39.90	5.96	8.00	T41300	33.24	4.96	6.66		
T31310			24.60	31.26			5.10	T41310			4.25		
T31080	4.50	0.63	12.10	17.75			2.77	T41080			2.31		
T31090			15.90	24.94	18.30	2.61	1.73	T41090	15.24	2.17	1.44		
T31100			21.60	35.70			1.11	T41100			0.93		
T31110			31.00	53.60			0.70	T41110			0.58		
T31420			14.20	17.15			14.30	T41420			11.91		
T31430	0.90	19.60	24.32	49.70	7.45	8.96	T41430	41.40	6.20	7.46			
T31440		27.70	35.08			5.73	T41440			4.77			
E0180-014-0620-M	0.36	0.36	15.75	44.45			0.11	E0180-014-0620S			0.09		
E0180-014-0750-M			19.05	60.96			0.07	E0180-014-0750S			0.06		
E0180-014-1000-M			25.40	93.73	3.42	0.31	0.05	E0180-014-1000S	2.85	0.26	0.04		
E0180-014-1250-M			31.75	126.75			0.04	E0180-014-1250S			0.03		
E0180-014-1500-M			38.10	159.51			0.02	E0180-014-1500S			0.02		
E0180-018-0620-M			0.46	0.46	15.75	31.75			0.39	E0180-018-0620S			0.32
E0180-018-0750-M					19.05	42.16			0.26	E0180-018-0750S			0.22
E0180-018-0880-M					22.35	52.83			0.21	E0180-018-0880S			0.18
E0180-018-1000-M					25.40	62.48			0.18	E0180-018-1000S			0.15
E0180-018-1120-M					28.45	72.39			0.14	E0180-018-1120S			0.12
E0180-018-1250-M					31.75	82.80	6.89	0.62	0.12	E0180-018-1250S	5.74	0.52	0.10
E0180-018-1370-M					34.80	92.71			0.11	E0180-018-1370S			0.09
E0180-018-1500-M					38.10	103.12			0.09	E0180-018-1500S			0.07
E0180-018-1750-M					44.45	123.44			0.09	E0180-018-1750S			0.07
E0180-018-2000-M					50.80	143.76			0.07	E0180-018-2000S			0.06
E0180-018-2250-M	57.15	164.08					0.05	E0180-018-2250S			0.04		
E0180-018-2500-M	63.50	184.66					0.05	E0180-018-2500S			0.04		
E0180-020-0620-M	0.51	0.51			15.75	28.19			0.67	E0180-020-0620S			0.55
E0180-020-0750-M					19.05	37.08			0.47	E0180-020-0750S			0.39
E0180-020-0880-M					22.35	45.97			0.35	E0180-020-0880S			0.29
E0180-020-1000-M			25.40	54.10			0.30	E0180-020-1000S			0.25		
E0180-020-1120-M			28.45	62.23			0.25	E0180-020-1120S			0.20		
E0180-020-1250-M			31.75	71.12	9.25	0.85	0.21	E0180-020-1250S	7.71	0.71	0.18		
E0180-020-1370-M			34.80	79.25			0.19	E0180-020-1370S			0.16		
E0180-020-1500-M			38.10	88.14			0.18	E0180-020-1500S			0.15		
E0180-020-1750-M			44.45	105.16			0.14	E0180-020-1750S			0.12		
E0180-020-2000-M			50.80	122.17			0.12	E0180-020-2000S			0.10		
E0180-020-2250-M			57.15	139.19			0.11	E0180-020-2250S			0.09		
E0180-020-2500-M			63.50	156.46			0.09	E0180-020-2500S			0.07		
E0180-022-0500-M			0.56	0.56	12.70	18.54			1.84	E0180-022-0500S			1.53
E0180-022-0620-M					15.75	25.65			1.10	E0180-022-0620S			0.92
E0180-022-0750-M					19.05	33.27			0.77	E0180-022-0750S			0.64
E0180-022-0880-M	22.35	40.89					0.60	E0180-022-0880S			0.50		
E0180-022-1000-M	25.40	47.24					0.49	E0180-022-1000S			0.41		
E0180-022-1120-M	28.45	54.10			11.56	0.89	0.42	E0180-022-1120S	9.63	0.74	0.35		
E0180-022-1250-M	31.75	61.72					0.35	E0180-022-1250S			0.29		
E0180-022-1370-M	34.80	68.58					0.32	E0180-022-1370S			0.26		
E0180-022-1500-M	38.10	75.95					0.28	E0180-022-1500S			0.23		
E0180-022-1750-M	44.45	90.17					0.23	E0180-022-1750S			0.19		
E0180-022-2000-M	50.80	103.38					0.21	E0180-022-2000S			0.18		
E0180-022-2250-M	57.15	121.41					0.18	E0180-022-2250S			0.15		
E0180-022-2500-M	63.50	136.14					0.16	E0180-022-2500S			0.13		
E0180-024-0620-M	0.61	0.61			15.75	23.88			1.73	E0180-024-0620S			1.44
E0180-024-0750-M					19.05	30.48			1.21	E0180-024-0750S			1.01
E0180-024-0880-M			22.35	37.34			0.93	E0180-024-0880S			0.77		
E0180-024-1000-M			25.40	43.43			0.77	E0180-024-1000S			0.64		
E0180-024-1120-M			28.45	49.78			0.65	E0180-024-1120S			0.54		
E0180-024-1250-M			31.75	56.64	15.35	1.38	0.56	E0180-024-1250S	12.79	1.15	0.47		
E0180-024-1370-M			34.80	62.74			0.51	E0180-024-1370S			0.42		
E0180-024-1500-M			38.10	69.60			0.44	E0180-024-1500S			0.37		
E0180-024-1750-M			44.45	82.55			0.37	E0180-024-1750S			0.31		
E0180-024-2000-M			50.80	95.50			0.32	E0180-024-2000S			0.26		
E0180-024-2250-M			57.15	108.46			0.28	E0180-024-2250S			0.23		
E0180-024-2500-M			63.50	121.41			0.25	E0180-024-2500S			0.20		
E0180-026-0500-M			0.66	0.66	12.70	16.76			4.26	E0180-026-0500S			3.55
E0180-026-0620-M					15.75	22.35	18.68	1.78	2.63	E0180-026-0620S	15.56	1.48	2.19
E0180-026-0750-M					19.05	28.45			1.86	E0180-026-0750S			1.55

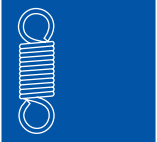

EXTENSION SPRINGS - MUSIC WIRE								STAINLESS STEEL / INOX			
Part Number	Do (mm)	d (mm)	Lo (mm)	L ₁ (mm)	P (N)	T (N)	R (N/mm)	Part Number	P (N)	T (N)	R (N/mm)
E0180-026-0880-M			22.35	34.54			1.44	E0180-026-0880S			1.20
E0180-026-1000-M			25.40	39.88			1.19	E0180-026-1000S			0.99
E0180-026-1120-M			28.45	45.21			1.03	E0180-026-1120S			0.86
E0180-026-1250-M			31.75	51.05			0.89	E0180-026-1250S			0.74
E0180-026-1370-M		0.66	34.80	56.90	18.68	1.78	0.79	E0180-026-1370S	15.36	1.48	0.66
E0180-026-1500-M			38.10	62.74			0.70	E0180-026-1500S			0.58
E0180-026-1750-M			44.45	73.91			0.58	E0180-026-1750S			0.48
E0180-026-2000-M			50.80	85.34			0.49	E0180-026-2000S			0.41
E0180-026-2250-M			57.15	98.55			0.42	E0180-026-2250S			0.35
E0180-026-2500-M			63.50	110.24			0.37	E0180-026-2500S			0.31
E0180-029-0620-M			15.75	20.83			4.64	E0180-029-0620S			3.87
E0180-029-0750-M			19.05	26.16			3.31	E0180-029-0750S			2.76
E0180-029-0880-M			22.35	31.50			2.57	E0180-029-0880S			2.14
E0180-029-1000-M			25.40	36.32			2.14	E0180-029-1000S			1.78
E0180-029-1120-M			28.45	41.40			1.82	E0180-029-1120S			1.52
E0180-029-1250-M		0.74	31.75	46.74	25.89	2.31	1.58	E0180-029-1250S	21.57	1.92	1.31
E0180-029-1370-M			34.80	51.56			1.40	E0180-029-1370S			1.17
E0180-029-1500-M			38.10	56.90			1.24	E0180-029-1500S			1.04
E0180-029-1750-M			44.45	67.31			1.03	E0180-029-1750S			0.86
E0180-029-2000-M			50.80	77.47			0.88	E0180-029-2000S			0.73
E0180-029-2250-M			57.15	87.88			0.77	E0180-029-2250S			0.64
E0180-029-2500-M	4.57		63.50	98.04			0.68	E0180-029-2500S			0.57
E0180-031-0500-M			12.70	15.49			10.40	E0180-031-0500S			8.66
E0180-031-0620-M			15.75	20.07			6.62	E0180-031-0620S			5.51
E0180-031-0750-M			19.05	24.89			4.75	E0180-031-0750S			3.96
E0180-031-0880-M			22.35	29.97			3.70	E0180-031-0880S			3.08
E0180-031-1000-M		0.79	25.40	34.29	30.25	2.67	3.12	E0180-031-1000S	25.20	2.22	2.60
E0180-031-1120-M			28.45	38.86			2.66	E0180-031-1120S			2.22
E0180-031-1250-M			31.75	43.69			2.29	E0180-031-1250S			1.91
E0180-031-1370-M			34.80	48.51			2.03	E0180-031-1370S			1.69
E0180-031-1500-M			38.10	53.09			1.84	E0180-031-1500S			1.53
E0180-031-1750-M			44.45	62.48			1.52	E0180-031-1750S			1.27
E0180-031-2000-M			50.80	71.88			1.31	E0180-031-2000S			1.09
E0180-031-2250-M		0.79	57.15	81.28	30.25	2.67	1.14	E0180-031-2250S	25.20	2.22	0.95
E0180-031-2500-M			63.50	92.20			0.98	E0180-031-2500S			0.82
E0180-031-2750-M			69.85	101.85			0.89	E0180-031-2750S			0.74
E0180-034-0620-M			15.75	19.05			10.82	E0180-034-0620S			9.01
E0180-034-0750-M			19.05	23.62			7.83	E0180-034-0750S			6.52
E0180-034-0880-M			22.35	28.19			6.13	E0180-034-0880S			5.11
E0180-034-1000-M			25.40	32.51			5.11	E0180-034-1000S			4.26
E0180-034-1120-M			28.45	36.83			4.38	E0180-034-1120S			3.65
E0180-034-1250-M		0.86	31.75	41.40	39.90	3.60	3.78	E0180-034-1250S	33.24	3.00	3.15
E0180-034-1370-M			34.80	45.47			3.38	E0180-034-1370S			2.82
E0180-034-1500-M			38.10	50.04			3.01	E0180-034-1500S			2.51
E0180-034-1750-M			44.45	58.93			2.50	E0180-034-1750S			2.08
E0180-034-2000-M			50.80	67.82			2.14	E0180-034-2000S			1.78
E0180-034-2250-M			57.15	76.71			1.87	E0180-034-2250S			1.56
E0180-034-2500-M			63.50	85.34			1.66	E0180-034-2500S			1.39
E0180-034-2750-M			69.85	94.23			1.49	E0180-034-2750S			1.24
T31200			13.50	19.75			3.07	T41200			2.56
T31210		0.70	17.70	27.70	22.60	3.39	1.92	T41210	18.83	2.83	1.60
T31220			24.00	39.60			1.23	T41220			1.03
T31230	5.00		34.50	59.50			0.77	T41230			0.64
T31540			15.80	19.05			15.90	T41540			13.25
T31550		1.00	21.80	27.00	60.80	9.17	9.90	T41550	50.65	7.64	8.25
T31560			30.80	38.92			6.37	T41560			5.31
T30880			12.70	25.80			0.51	T40880			0.43
T30890			15.70	36.60			0.31	T40890			0.26
T30900		0.50	20.20	52.90	7.80	1.02	0.21	T40900	6.50	0.85	0.18
T30910			27.70	80.00			0.13	T40910			0.11
T30920			37.70	116.10			0.09	T40920			0.08
T31320	5.50		15.00	21.40			4.00	T41320			3.33
T31330			19.80	30.00			2.50	T41330			2.08
T31340		0.80	27.00	43.00	30.20	4.79	1.60	T41340	25.16	3.99	1.33
T31350			39.00	64.60			1.00	T41350			0.83
T31360			290.00	515.00			0.11	T41360			0.09
T31670			17.40	20.94			17.50	T41670			14.58
T31680		1.10	24.00	29.66	72.80	10.77	11.00	T41680	60.64	8.97	9.16
T31690			33.90	42.74			7.00	T41690			5.83
T31000	6.00	0.55	13.90	28.00	9.50	1.09	0.58	T41000	7.91	0.91	0.48
T31010			17.20	39.70			0.36	T41010			0.30

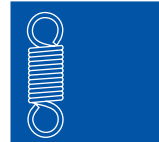

EXTENSION SPRINGS - MUSIC WIRE								STAINLESS STEEL / INOX			
Part Number	Do (mm)	d (mm)	Lo (mm)	L ₁ (mm)	P (N)	T (N)	R (N/mm)	Part Number	P (N)	T (N)	R (N/mm)
T31020			22.10	57.20			0.23	T41020			0.19
T31030			30.40	86.60			0.15	T41030			0.13
T31040	6.00	1.20	41.40	125.70	85.30	12.63	0.11	T41040	71.05	10.52	0.09
T31790			19.00	22.80			19.10	T41790			15.91
T31800			26.20	32.28			12.00	T41800			10.00
T31810			37.00	46.50			7.63	T41810			6.36
E0240-018-0620-M			15.75	32.51			0.28	E0240-018-0620S			0.23
E0240-018-0750-M			19.05	49.78			0.16	E0240-018-0750S			0.13
E0240-018-0880-M			22.35	68.07			0.11	E0240-018-0880S			0.09
E0240-018-1000-M			25.40	83.82			0.09	E0240-018-1000S			0.07
E0240-018-1250-M		0.46	31.75	118.11	5.25	0.49	0.05	E0240-018-1250S	4.37	0.41	0.04
E0240-018-1500-M			38.10	152.15			0.04	E0240-018-1500S			0.03
E0240-018-2000-M			50.80	219.46			0.04	E0240-018-2000S			0.03
E0240-018-2500-M			63.50	287.78			0.02	E0240-018-2500S			0.02
E0240-018-2750-M			69.85	321.82			0.02	E0240-018-2750S			0.02
E0240-022-0620-M			15.75	26.92			0.75	E0240-022-0620S			0.63
E0240-022-0750-M			19.05	38.86			0.42	E0240-022-0750S			0.35
E0240-022-0880-M			22.35	50.80			0.30	E0240-022-0880S			0.25
E0240-022-1000-M			25.40	61.98			0.23	E0240-022-1000S			0.19
E0240-022-1120-M			28.45	73.15			0.19	E0240-022-1120S			0.16
E0240-022-1250-M			31.75	85.09			0.16	E0240-022-1250S			0.13
E0240-022-1370-M		0.56	34.80	96.01	9.21	0.85	0.14	E0240-022-1370S	7.67	0.71	0.12
E0240-022-1500-M			38.10	108.20			0.12	E0240-022-1500S			0.10
E0240-022-1750-M			44.45	131.06			0.11	E0240-022-1750S			0.09
E0240-022-2000-M			50.80	154.18			0.09	E0240-022-2000S			0.07
E0240-022-2250-M			57.15	177.29			0.07	E0240-022-2250S			0.06
E0240-022-2500-M			63.50	200.41			0.05	E0240-022-2500S			0.04
E0240-022-2750-M			69.85	223.52			0.05	E0240-022-2750S			0.04
E0240-026-0500-M			12.70	15.24			5.06	E0240-026-0500S			4.22
E0240-026-0620-M			15.75	23.62			1.70	E0240-026-0620S			1.42
E0240-026-0750-M			19.05	32.77			0.98	E0240-026-0750S			0.82
E0240-026-0880-M			22.35	41.66			0.70	E0240-026-0880S			0.58
E0240-026-1000-M			25.40	50.04			0.53	E0240-026-1000S			0.44
E0240-026-1120-M			28.45	58.67			0.44	E0240-026-1120S			0.37
E0240-026-1250-M			31.75	67.06			0.37	E0240-026-1250S			0.31
E0240-026-1370-M			34.80	75.18			0.32	E0240-026-1370S			0.26
E0240-026-1500-M			38.10	83.31			0.28	E0240-026-1500S			0.23
E0240-026-1750-M		0.66	44.45	100.33	14.68	1.33	0.23	E0240-026-1750S	12.23	1.11	0.19
E0240-026-2000-M	6.10		50.80	116.84			0.19	E0240-026-2000S			0.16
E0240-026-2250-M			57.15	136.65			0.18	E0240-026-2250S			0.15
E0240-026-2500-M			63.50	153.92			0.14	E0240-026-2500S			0.12
E0240-026-2750-M			69.85	171.20			0.14	E0240-026-2750S			0.12
E0240-026-3000-M			76.20	188.47			0.12	E0240-026-3000S			0.10
E0240-026-3500-M			88.90	222.50			0.11	E0240-026-3500S			0.09
E0240-026-4000-M			101.60	257.56			0.09	E0240-026-4000S			0.07
E0240-026-4500-M			114.30	291.85			0.07	E0240-026-4500S			0.06
E0240-026-5000-M			127.00	326.64			0.07	E0240-026-5000S			0.06
E0240-029-0620-M			15.75	22.10			2.89	E0240-029-0620S			2.41
E0240-029-0750-M			19.05	29.72			1.72	E0240-029-0750S			1.43
E0240-029-0880-M			22.35	37.34			1.23	E0240-029-0880S			1.02
E0240-029-1000-M			25.40	44.20			0.96	E0240-029-1000S			0.80
E0240-029-1120-M			28.45	51.31			0.79	E0240-029-1120S			0.66
E0240-029-1250-M			31.75	58.93			0.67	E0240-029-1250S			0.55
E0240-029-1370-M			34.80	65.79			0.58	E0240-029-1370S			0.48
E0240-029-1500-M			38.10	73.41			0.51	E0240-029-1500S			0.42
E0240-029-1750-M		0.74	44.45	88.14	20.02	1.78	0.42	E0240-029-1750S	16.68	1.48	0.35
E0240-029-2000-M			50.80	102.62			0.35	E0240-029-2000S			0.29
E0240-029-2250-M			57.15	117.35			0.30	E0240-029-2250S			0.25
E0240-029-2500-M			63.50	131.83			0.26	E0240-029-2500S			0.22
E0240-029-2750-M			69.85	146.56			0.25	E0240-029-2750S			0.20
E0240-029-3000-M			76.20	161.04			0.21	E0240-029-3000S			0.18
E0240-029-3500-M			88.90	190.75			0.18	E0240-029-3500S			0.15
E0240-029-4000-M			101.60	219.71			0.16	E0240-029-4000S			0.13
E0240-029-4500-M			114.30	249.43			0.14	E0240-029-4500S			0.12
E0240-029-5000-M			127.00	278.38			0.12	E0240-029-5000S			0.10
E0240-031-0620-M			15.75	21.34			3.99	E0240-031-0620S			3.32
E0240-031-0750-M			19.05	28.19			2.42	E0240-031-0750S			2.02
E0240-031-0880-M		0.79	22.35	35.05	23.58	2.22	1.73	E0240-031-0880S	19.64	1.85	1.44
E0240-031-1000-M			25.40	41.66			1.31	E0240-031-1000S			1.09
E0240-031-1120-M			28.45	48.01			1.14	E0240-031-1120S			0.95
E0240-031-1250-M			31.75	54.36			0.93	E0240-031-1250S			0.77

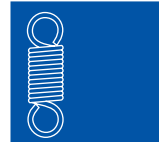

EXTENSION SPRINGS - MUSIC WIRE								STAINLESS STEEL / INOX			
Part Number	Do (mm)	d (mm)	Lo (mm)	L ₁ (mm)	P (N)	T (N)	R (N/mm)	Part Number	P (N)	T (N)	R (N/mm)
E0240-031-1370-M			34.80	59.94			0.84	E0240-031-1370S			0.70
E0240-031-1500-M			38.10	67.06			0.74	E0240-031-1500S			0.61
E0240-031-1750-M			44.45	80.01			0.60	E0240-031-1750S			0.50
E0240-031-2000-M			50.80	92.71			0.51	E0240-031-2000S			0.42
E0240-031-2250-M			57.15	105.66			0.44	E0240-031-2250S			0.37
E0240-031-2500-M		0.79	63.50	118.36	23.58	2.22	0.39	E0240-031-2500S	19.64	1.85	0.32
E0240-031-2750-M			69.85	134.37			0.33	E0240-031-2750S			0.28
E0240-031-3000-M			76.20	147.57			0.30	E0240-031-3000S			0.25
E0240-031-3500-M			88.90	172.21			0.26	E0240-031-3500S			0.22
E0240-031-4000-M			101.60	198.37			0.23	E0240-031-4000S			0.19
E0240-031-4500-M			114.30	224.54			0.19	E0240-031-4500S			0.16
E0240-031-5000-M			127.00	250.70			0.18	E0240-031-5000S			0.15
E0240-034-0620-M			15.75	20.32			6.30	E0240-034-0620S			5.25
E0240-034-0750-M			19.05	26.42			3.87	E0240-034-0750S			3.22
E0240-034-0880-M			22.35	32.00			2.80	E0240-034-0880S			2.33
E0240-034-1000-M			25.40	38.10			2.22	E0240-034-1000S			1.85
E0240-034-1120-M			28.45	43.69			1.86	E0240-034-1120S			1.55
E0240-034-1250-M			31.75	49.78			1.56	E0240-034-1250S			1.30
E0240-034-1370-M			34.80	55.37			1.37	E0240-034-1370S			1.14
E0240-034-1500-M			38.10	61.47			1.21	E0240-034-1500S			1.01
E0240-034-1750-M		0.86	44.45	73.41	31.14	2.89	0.98	E0240-034-1750S	25.94	2.41	0.82
E0240-034-2000-M			50.80	85.09			0.82	E0240-034-2000S			0.69
E0240-034-2250-M			57.15	96.77			0.72	E0240-034-2250S			0.60
E0240-034-2500-M			63.50	108.46			0.63	E0240-034-2500S			0.53
E0240-034-2750-M			69.85	120.40			0.56	E0240-034-2750S			0.47
E0240-034-3000-M			76.20	132.08			0.51	E0240-034-3000S			0.42
E0240-034-3500-M			88.90	155.70			0.42	E0240-034-3500S			0.35
E0240-034-4000-M			101.60	179.07			0.37	E0240-034-4000S			0.31
E0240-034-4500-M			114.30	202.44			0.32	E0240-034-4500S			0.26
E0240-034-5000-M			127.00	226.06			0.28	E0240-034-5000S			0.23
E0240-037-0620-M			15.75	19.56			9.58	E0240-037-0620S			7.98
E0240-037-0750-M	6.10		19.05	24.89			6.01	E0240-037-0750S			5.01
E0240-037-1000-M			25.40	35.56			3.47	E0240-037-1000S			2.89
E0240-037-1120-M			28.45	40.89			2.87	E0240-037-1120S			2.39
E0240-037-1250-M			31.75	45.97			2.45	E0240-037-1250S			2.04
E0240-037-1370-M			34.80	51.05			2.17	E0240-037-1370S			1.81
E0240-037-1500-M			38.10	55.88			1.96	E0240-037-1500S			1.63
E0240-037-1750-M			44.45	66.80			1.56	E0240-037-1750S			1.30
E0240-037-2000-M		0.94	50.80	77.22	38.70	3.56	1.33	E0240-037-2000S	32.24	2.97	1.11
E0240-037-2250-M			57.15	87.63			1.14	E0240-037-2250S			0.95
E0240-037-2500-M			63.50	97.79			1.02	E0240-037-2500S			0.85
E0240-037-2750-M			69.85	108.46			0.91	E0240-037-2750S			0.76
E0240-037-3000-M			76.20	118.62			0.82	E0240-037-3000S			0.69
E0240-037-3250-M			82.55	131.06			0.74	E0240-037-3250S			0.61
E0240-037-3500-M			88.90	141.73			0.67	E0240-037-3500S			0.55
E0240-037-4000-M			101.60	162.05			0.58	E0240-037-4000S			0.48
E0240-037-4500-M			114.30	183.39			0.51	E0240-037-4500S			0.42
E0240-037-5000-M			127.00	204.47			0.46	E0240-037-5000S			0.38
E0240-041-0750-M			19.05	23.62			10.24	E0240-041-0750S			8.53
E0240-041-1000-M			25.40	33.27			6.06	E0240-041-1000S			5.05
E0240-041-1120-M			28.45	37.85			5.06	E0240-041-1120S			4.22
E0240-041-1250-M			31.75	42.67			4.29	E0240-041-1250S			3.57
E0240-041-1370-M			34.80	47.24			3.77	E0240-041-1370S			3.14
E0240-041-1500-M			38.10	52.32			3.33	E0240-041-1500S			2.77
E0240-041-1750-M			44.45	61.72			2.71	E0240-041-1750S			2.26
E0240-041-2000-M		1.04	50.80	71.37	51.82	4.67	2.29	E0240-041-2000S	43.17	3.89	1.91
E0240-041-2250-M			57.15	80.77			2.00	E0240-041-2250S			1.66
E0240-041-2500-M			63.50	90.42			1.75	E0240-041-2500S			1.46
E0240-041-2750-M			69.85	100.08			1.56	E0240-041-2750S			1.30
E0240-041-3000-M			76.20	109.47			1.42	E0240-041-3000S			1.18
E0240-041-3500-M			88.90	128.52			1.19	E0240-041-3500S			0.99
E0240-041-4000-M			101.60	147.57			1.03	E0240-041-4000S			0.86
E0240-041-4500-M			114.30	166.88			0.89	E0240-041-4500S			0.74
E0240-041-5000-M			127.00	185.67			0.81	E0240-041-5000S			0.67
T31450			17.10	24.53			4.23	T41450			3.52
T31460	6.30	0.90	22.50	34.40	37.10	5.58	2.65	T41460	30.90	4.65	2.21
T31470			30.60	49.20			1.70	T41470			1.42
T31480			44.10	73.80			1.06	T41480			0.88
T31120			16.10	32.70			0.62	T41120			0.52
T31130	7.00	0.63	19.90	46.50	12.20	1.67	0.39	T41130	10.16	1.39	0.33
T31140			25.60	67.20			0.25	T41140			0.21

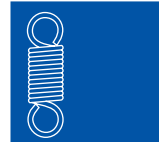

EXTENSION SPRINGS - MUSIC WIRE								STAINLESS STEEL / INOX			
Part Number	Do (mm)	d (mm)	Lo (mm)	L ₁ (mm)	P (N)	T (N)	R (N/mm)	Part Number	P (N)	T (N)	R (N/mm)
T31150		0.63	35.00	101.50	12.20	1.67	0.16	T41150	10.16	1.39	0.13
T31160			47.60	147.30			0.11	T41160			0.09
T31570			19.00	27.17			4.71	T41570			3.92
T31580			25.00	38.10			2.94	T41580			2.45
T31590	7.00	1.00	34.00	54.40	45.30	6.78	1.83	T41590	37.73	5.66	1.52
T31600			49.00	81.70			1.18	T41600			0.98
T31610			290.00	510.00			0.18	T41610			0.15
T31920			22.10	26.46			22.30	T41920			18.58
T31930		1.40	30.50	37.48	114.00	16.88	13.90	T41930	95.96	14.06	11.58
T31940			43.10	54.00			8.91	T41940			7.42
T31240			17.50	34.40			0.78	T41240			0.65
T31250			21.70	48.70			0.49	T41250			0.41
T31260		0.70	28.00	70.20	15.40	2.18	0.31	T41260	12.83	1.81	0.26
T31270			38.50	106.00			0.20	T41270			0.17
T31280	7.50		52.50	153.50			0.13	T41280			0.11
T31700			20.60	28.90			5.69	T41700			4.74
T31710		1.10	27.20	40.50	55.50	8.25	3.55	T41710	46.23	6.87	2.96
T31720			37.10	57.90			2.28	T41720			1.90
T31730			53.60	86.80			1.42	T41730			1.18
E0300-031-1000-M			25.40	46.74			0.82	E0300-031-1000S			0.69
E0300-031-1120-M			28.45	55.63			0.65	E0300-031-1120S			0.54
E0300-031-1250-M			31.75	65.02			0.53	E0300-031-1250S			0.44
E0300-031-1370-M			34.80	73.91			0.46	E0300-031-1370S			0.38
E0300-031-1500-M			38.10	83.57			0.39	E0300-031-1500S			0.32
E0300-031-1750-M		0.79	44.45	101.85	19.53	1.73	0.32	E0300-031-1750S	16.27	1.44	0.26
E0300-031-2000-M			50.80	120.14			0.26	E0300-031-2000S			0.22
E0300-031-2250-M			57.15	138.43			0.21	E0300-031-2250S			0.18
E0300-031-2500-M			63.50	156.72			0.19	E0300-031-2500S			0.16
E0300-031-2750-M			69.85	175.26			0.18	E0300-031-2750S			0.15
E0300-031-3000-M			76.20	193.55			0.16	E0300-031-3000S			0.13
E0300-037-0750-M			19.05	25.65			4.45	E0300-037-0750S			3.71
E0300-037-1000-M			25.40	39.62			2.07	E0300-037-1000S			1.72
E0300-037-1120-M			28.45	46.23			1.65	E0300-037-1120S			1.37
E0300-037-1250-M			31.75	53.34			1.35	E0300-037-1250S			1.12
E0300-037-1370-M			34.80	60.20			1.16	E0300-037-1370S			0.96
E0300-037-1500-M		0.94	38.10	67.31	32.03	2.89	1.00	E0300-037-1500S	26.68	2.41	0.83
E0300-037-1750-M			44.45	81.28			0.79	E0300-037-1750S			0.66
E0300-037-2000-M			50.80	95.25			0.65	E0300-037-2000S			0.54
E0300-037-2250-M			57.15	109.22			0.56	E0300-037-2250S			0.47
E0300-037-2500-M			63.50	123.19			0.49	E0300-037-2500S			0.41
E0300-037-2750-M			69.85	137.16			0.44	E0300-037-2750S			0.37
E0300-037-3000-M	7.62		76.20	150.88			0.39	E0300-037-3000S			0.32
E0300-049-1000-M			25.40	32.51			8.88	E0300-049-1000S			7.40
E0300-049-1120-M			28.45	37.34			7.18	E0300-049-1120S			5.98
E0300-049-1250-M			31.75	42.42			5.94	E0300-049-1250S			4.95
E0300-049-1370-M			34.80	46.99			5.13	E0300-049-1370S			4.27
E0300-049-1500-M			38.10	52.32			4.47	E0300-049-1500S			3.72
E0300-049-1750-M		1.24	44.45	61.98	69.39	6.23	3.57	E0300-049-1750S	57.80	5.19	2.97
E0300-049-2000-M			50.80	71.88			2.98	E0300-049-2000S			2.48
E0300-049-2250-M			57.15	81.79			2.56	E0300-049-2250S			2.13
E0300-049-2500-M			63.50	91.69			2.24	E0300-049-2500S			1.87
E0300-049-2750-M			69.85	101.60			2.00	E0300-049-2750S			1.66
E0300-049-3000-M			76.20	111.25			1.79	E0300-049-3000S			1.49
E0300-055-1000-M			25.40	30.73			16.34	E0300-055-1000S			13.61
E0300-055-1120-M			28.45	35.05			13.31	E0300-055-1120S			11.09
E0300-055-1250-M			31.75	39.62			11.09	E0300-055-1250S			9.24
E0300-055-1370-M			34.80	43.69			9.60	E0300-055-1370S			8.00
E0300-055-1500-M			38.10	48.26			8.39	E0300-055-1500S			6.99
E0300-055-1750-M		1.40	44.45	57.15	94.97	8.54	6.74	E0300-055-1750S	78.96	7.11	5.61
E0300-055-2000-M			50.80	66.04			5.64	E0300-055-2000S			4.70
E0300-055-2250-M			57.15	74.93			4.85	E0300-055-2250S			4.04
E0300-055-2500-M			63.50	83.82			4.26	E0300-055-2500S			3.55
E0300-055-2750-M			69.85	92.71			3.78	E0300-055-2750S			3.15
E0300-055-3000-M			76.20	101.60			3.41	E0300-055-3000S			2.84
T32050			25.30	30.18			25.40	T42050			21.16
T32060	8.00	1.60	34.90	42.71	146.00	21.81	15.90	T42060	121.62	18.17	13.25
T32070			49.30	61.50			10.20	T42070			8.50
T31820			23.00	32.85			5.43	T41820			4.52
T31830	8.50	1.20	30.20	46.00	62.80	9.22	3.39	T41830	52.31	7.68	2.82
T31840			41.00	65.60			2.17	T41840			1.81
T31850			59.00	98.60			1.35	T41850			1.13

